

INSTRUCTION MANUAL

PhaseGuard C/T/HT



In-line Interface Monitor

SIGRIST-PHOTOMETER AG
Hofurlistrasse 1
CH-6373 Ennetbürgen
Switzerland

Tel. +41 41 624 54 54
Fax +41 41 624 54 55
info@photometer.com
www.photometer.com

Content

1.	Notes to the user	1
1.1.	General information	1
1.2.	Explanation of symbols	2
2.	Instrument description	3
2.1.	General information about the PhaseGuard	3
2.2.	Technical data	8
3.	General safety pointers	10
3.1.	Behavior in emergency	10
3.2.	Dangers when using properly	11
3.3.	Residual risk	12
3.4.	Warning and danger symbols on the instrument	12
4.	Mechanical mounting	13
5.	Electrical installation	14
5.1.	Safety pointers for the electrical installation	14
5.2.	Installation of the PhaseGuard	15
5.3.	Installation of the SICON control unit, field bus	16
6.	Initial start-up	17
6.1.	Commissioning procedure	17
6.2.	Perform zero calibration	19
7.	Operation	20
8.	Servicing	21
8.1.	Servicing schedule	21
8.2.	Replacing the desiccant	22
8.3.	Cleaning the sensor head	23
8.4.	Replacing gasket of the in-line housing and blanking plate	25
9.	Troubleshooting	27
10.	Customer service information	27
11.	Decommissioning & storage	28
12.	Packaging & transport	29
13.	Disposal	30
14.	Spare parts	31
15.	Appendix	32
15.1.	Dimension sheet PhaseGuard-MB	32
15.2.	Overview of gaskets on the PhaseGuard	33
15.3.	PhaseGuard connection diagram	34
16.	Index	35

Terms used in this document (glossary)

Please refer to our website for specialist terms: www.photometer.com

1. Notes to the user

1.1. General information

Purpose of the Instruction Manual

This Instruction Manual provides the user with the most important information up to and including commissioning. Information such as operation, servicing, troubleshooting and more are described in greater detail in the Reference Manual.

Target group

The Instruction Manual is intended for all persons who are responsible for mounting, installing and commissioning the instrument.

Additional documentation

DOC. NO.	TITLE	CONTENT
11027E	Reference Manual	More sophisticated menu functions and work-steps for advanced users. This document can be downloaded from www.photometer.com (first time registration required).
11018E	Data sheet	Descriptions and technical data about the photometer.
11052E	Service Manual	Repair and conversion instructions for service engineers.
11050DEF	Declaration of conformity	Compliance with the underlying directives and standards.

Copyright regulations

This Instruction Manual has been written by SIGRIST PHOTOMETER AG. Copying or modifying the content or giving this document to third parties is permitted only with express written consent.

Storage location of the Instruction Manual

The Instruction Manual is a component of the product and should always be close at hand. Registered users can download the latest version (color) at www.photometer.com. It can also be ordered from our representative in your country. → Section 10

1.2. Explanation of symbols

Danger symbols

Below is a description of all danger symbols that occur in this Instruction Manual.



DANGER!

Danger due to electrical shock that may result in serious bodily injury or death.

Non-observance of this danger warning may lead to electrical shocks and death.



**EXPLOSION
HAZARD!**

Danger due to explosion that may result in serious bodily injury or death.

Non-observance of this notice may cause explosions resulting in serious material damage and death.



WARNING!

Warning about bodily injury or hazards to health with long-term effects.

Non-observance of this warning may lead to injuries with possible long-term effects.



CAUTION!

Notice about possible material damage.

Non-observance of this notice may cause material damage to the instrument and its peripherals.

Pictograms

Below is an explanation of all **pictograms** that occur in this Instruction Manual.



Additional information about the current topic.



Practical procedures when working with the photometer and control unit.



Work on the PC.

2. Instrument description

2.1. General information about the PhaseGuard

2.1.1. View of a measuring station

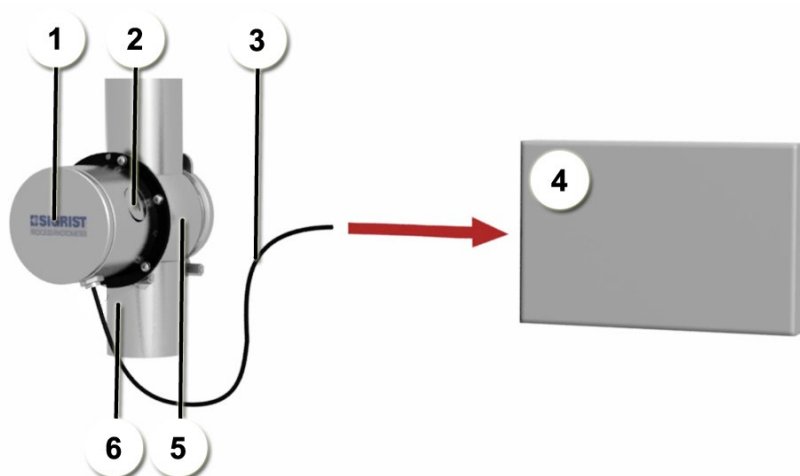

Figure 1: Overview of PhaseGuard C/ T/ HT

①	Photometer PhaseGuard	②	USB interface for configuring the instrument
③	Connection cable between the instrument and the customer-side control system	④	Customer-side control system
⑤	Varivent® in-line housing or compatible (optional)	⑥	Sample line

2.1.2. Proper use

The PhaseGuard and its peripherals are designed to detect phase transitions in liquids.

Possible areas of application:

- Food and beverage industry
- Milk processing industry
- Chemical and pharmaceutical industry

2.1.3. User requirements

- The instrument may be operated only by trained technical personnel.
- The instrument may be operated only by persons who are familiar with the content of the Instruction Manual and Reference Manual.

2.1.4. Conformity

Current technological principles were followed in designing and manufacturing the photometer. They comply with the usual guidelines concerning duty to take due care and safety.

The system meets the requirements applicable within the European Union (EU) for electromagnetic compatibility (EMC) and low voltage directives (LVD) and has the CE mark.

Please refer to the separate declaration of conformity for details (document 11050DEF).



2.1.5. Use restrictions

Explosion hazard during operation in an inappropriate environment.

Use in explosion hazardous areas may cause explosions that could be lethal to persons in the vicinity.

- It is not permitted to operate the instrument in explosion hazardous areas or rooms.
- It is not permitted to use the instrument with explosive media.



**EXPLOSION
HAZARD!**

Danger during operation with inappropriate media.

The use of too hot or aggressive media may cause leakage that could be lethal to persons in the vicinity.

It is not permitted to use the measuring instrument for applications in which the medium can attack it. Parts which contact the media: stainless steel, sapphire, gaskets.



DANGER!

2.1.6. Dangers when not used properly

Operation when not used properly.

Improper use can cause injuries to persons, process-related consequential damage and damage to the instrument itself and its peripherals.

In the following cases the manufacturer cannot guarantee the protection of persons and the instrument and therefore assumes no legal responsibility:

- The instrument is used in a way not included in the described area of application.
- The instrument is not properly mounted.
- The instrument is not installed and operated in accordance with the Instruction Manual.
- If the instrument has been operated with accessories which SIGRIST-PHOTOMETER AG has not expressly recommended.
- Improper changes to the instrument have been performed.
- The instrument has not been operated within the specifications, in particular concerning pressure and temperature.



DANGER!

2.1.7. Identification of the PhaseGuard

The photometer displays the following rating plate:

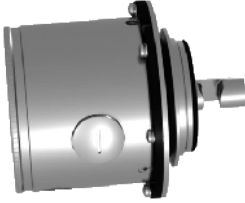
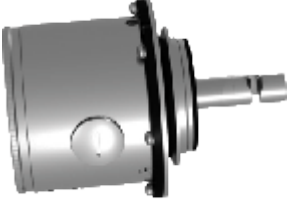
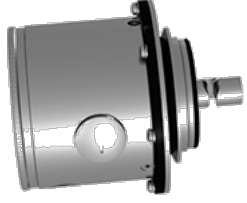



Figure 2: PhaseGuard rating plate





①	Manufacturer	②	Country of origin
③	Product name	④	Serial number
⑤	Date of manufacture	⑥	Service voltage
⑦	Frequency range	⑧	Power
⑨	Observe the Instruction Manual.	⑩	Disposal information → Section 13

2.1.8. Scope of delivery and accessories

Scope of delivery

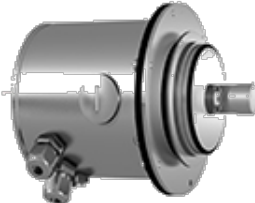
PCS.	ART. NO.	NAME	VIEW	VARIANT
1	118676	PhaseGuard C	 Length of sensor head: 33 mm Path length: 10 mm	Detection of phase transitions based on color change
1	118677	PhaseGuard T		Detection of phase transitions in media with mid-range turbidities
1	119788	PhaseGuard T		Sensor head made of Hastelloy
1	118678	PhaseGuard HT	 Length of sensor head: 56.5 mm Path length: 5 mm	Detection of phase transitions with high turbidities
1	119123	PhaseGuard HC		For liquids with high absorption levels
1	119675	PhaseGuard HT < DN65	 Length of sensor head: 28 mm Path length: 5 mm	Detection of phase transitions at high turbidities for Varivent® housing < DN65
1	20012	Instruction Manual		11026D German
				11026E English
				11026F French
1	118730	USB cable		

Optional accessories:

PCS.	ART. NO.	NAME	VIEW	VARIANT
1	118695	PhaseGuard with integrated field bus interface recognizable by the larger housing, the two cable penetrations and M12 connector		Profibus DP
	118696			RTU Modbus
1	118342	SICON control unit		
1	119040	SICON M Multichannel control unit		
1	120444	Device cable, 8-pole, 10 m with connector		
1	Various	Varivent® in-line housing		Various nominal widths
1	118740	Uncoated blanking plate		
1	20012	Reference Manual as PDF		11027D German
				11027E English

2.2. Technical data

TURBIDITY MEASUREMENT	VALUES
Measuring principle	Absorption <ul style="list-style-type: none"> ■ at 880 nm (T/HT) ■ at 430 nm (C/HC)
Measurement span	0 .. 100% absorption
Measuring range	0 .. 100% absorption
Sample temperature	-10 .. +100°C 120°C max. 2 hr
Ambient temperature	-10 .. +50°C
Pressure	1 MPa (10 bar) / 100°C
Resolution	0.5% absorption
Warm-up time	< 3 min
Repeatability (2 measurements with 1 instrument)	0.5% absorption
Linearity	0.5% absorption
Temperature stability	±0.05%/K (full scale)
Reaction time	< 0.3 s at 0 seconds integration time (step response → limit switch)
Ambient humidity	0 .. 100% relative humidity
Path lengths	<ul style="list-style-type: none"> ■ 10 mm (T/C) ■ 5 mm (HC/HT)
Outputs	<ul style="list-style-type: none"> ■ 1 x 4 .. 20 mA, galvanically separated up to max. 35 VDC relative to ground and max. 500 Ω burden ■ 2 x switching transistor with open collector U_{EXT} 3 .. 30 VDC, I_L max. 8 mA
Interfaces	<ul style="list-style-type: none"> ■ USB (for configuration via text file) ■ Modbus RTU / Profibus DP (both optional) ■ To optional SICON control unit

PHOTOMETER	VALUES
Service voltage	9 .. 30 VDC, 2 W (3 W with Profibus DP)
Material	<ul style="list-style-type: none"> ■ Housing: stainless steel 1.4301 or 1.4307 ■ Sensor head stainless steel 1.4404 or better ■ Hastelloy for PhaseGuard T (optional)
Window	Sapphire
Weight	<ul style="list-style-type: none"> ■ Approx. 2.1 kg ■ Approx. 2.5 kg (PhaseGuard with interface card)
Dimensions	<p>Ø 120 x 143 mm for instrument types T and C Ø 120 x 164.5 mm with interface card Ø 120 x 166.5 mm for instrument type HT Ø 120 x 188 mm with interface card Detailed dimension drawing PHASEGUARD-MB</p>
Pipe connections	<ul style="list-style-type: none"> ■ Minimum DN 40 for instrument types T and C with Varivent® or compatible connections ■ Minimum DN 65 for instrument type HT with Varivent® or compatible connections
Protection type	IP66

3. General safety pointers

3.1. Behavior in emergency



Behavior in emergency:
 SIGRIST-PHOTOMETER AG instruments have no on/off switch. This is installed customer-side. Before commissioning, clarify the following points:

- Position of the on/off switch and the way it works.
- Where and how the sample supply can be stopped.
- Who the responsible authorities are.

PROCEDURE IN AN EMERGENCY!

	MEASURE	NOTES
1.	Interrupt the service voltage to the measuring station.	
2.	Interrupt sample supply.	
3.	Secure emergency location.	
4.	Notify responsible institution.	

3.2. Dangers when using properly



DANGER!

Electrical shock due to damaged instrument or cabling.

Touching damaged cables may lead to electrical shocks with lethal consequences.

- The instrument may be operated only when the cables are undamaged.
- The instrument may be operated only if it has been properly installed or repaired.



DANGER!

Dangerous voltage inside the instrument due to galvanically separated current output.

Touching the galvanically isolated current output may lead to electrical shocks with lethal consequences.

- The instrument must never be operated when the housing is removed.
- The instrument may be opened only by trained personnel.



DANGER!

Bodily injury due to escaping sample liquid.

Contact with the medium may lead to burns, caustic irritations or poisoning with lethal consequences.

- The instrument must never be connected to leaking sample lines and operated.
- The local clothing regulations must be observed during operation.
- The local safety precautions must be observed during operation.



WARNING!

Damage due to incorrect power supply.

If the instrument is connected to an incorrect service voltage, it can be damaged.

The instrument may be connected only to voltage sources as specified on the rating plate.



CAUTION!

Damage to the instrument caused by humidity or condensation entering the instrument when it is opened:

If moisture enters the instrument, it can be damaged.

- Work on the inside of the instrument may be performed only in a dry room and at room temperature. The instrument should be warm from operation or at room temperature. (Condensation on optical and electrical surfaces must be avoided.)
- The instrument may be opened only under these conditions (e.g. removing cover to the usb interface).



CAUTION!

Use of aggressive chemicals.

The use of aggressive cleaning agents can destroy surfaces on the instrument that are relevant to measurement.

- Do not use aggressive chemicals or cleaning agents when cleaning.
- Thoroughly clean the instrument with a neutral cleaning agent if it has come into contact with aggressive chemicals.



CAUTION!

If the instrument changes hands, always include the Instruction Manual.

If the Instruction Manual is lost, you can request a replacement.

Registered users can download the current version at www.photometer.com.

3.3. Residual risk



DANGER!

During operation with hot or dangerous media, the possibility of leakage cannot be completely excluded.

Contact with the medium may lead to burns, caustic irritations or poisoning with lethal consequences.

- The operator is responsible for using the instrument for this purpose.
- The operator must ensure that additional protection measures such as safety clothing and similar items are available and are put to use.
- To avoid faulty measurement values as much as possible, the maintenance duties must be carried out according to the servicing schedule.
- Evaluate digital output warnings and error messages to recognize them.

3.4. Warning and danger symbols on the instrument



CAUTION!

There are no warning or danger symbols on the PhaseGuard.

Users must ensure that they observe the safety measures as specified in the Instruction Manual when working with the photometer and its peripheral equipment at all times.

Important to note:

- Sections 1.2 and 3.2.
- Observe local safety pointers when performing the described procedures.

4. Mechanical mounting

The instrument can be installed in horizontal or vertical sample lines using the standards-compliant in-line housing. → Figure 4



The mounting dimensional drawing (PHASEGUARD-MB) provides detailed information about the dimensions.

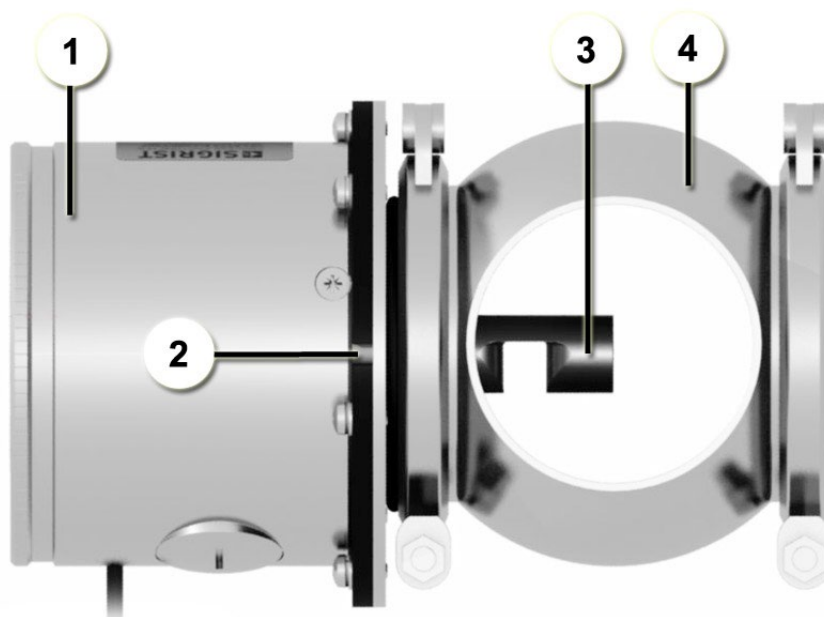

Figure 3: Position of the sensor in horizontal mounting

①	Photometer	②	Centering pin on the instrument
③	Sensor with measurement opening pointing downward	④	Varivent® sample line

Basics of mounting the photometer

- The photometer must be mounted in the line at least 0.5 m away from sight glasses and other unwanted light sources.
- In the vertical mounting position, the centering pin (2, Figure 3) must point upward (X, Figure 4).
- In the horizontal mounting position, the centering pin (2, Figure 3) must point to the right (Y, Figure 4).

Mounting position of the photometer

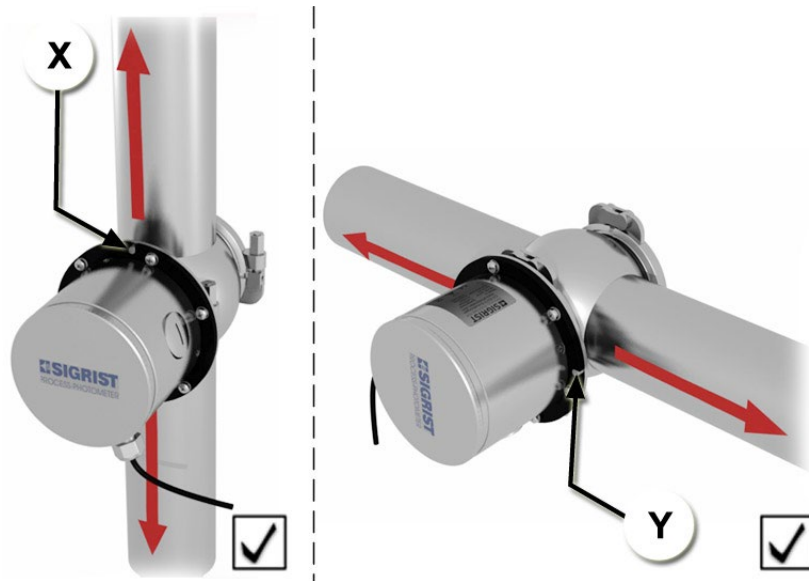

Figure 4: Correct installation in the vertical or horizontal sample lines



Figure 5: Incorrect mounting position

5. Electrical installation

5.1. Safety pointers for the electrical installation



Dangerous voltage inside the instrument:

Connecting electrical lines can be life threatening. Parts of the system can also be damaged. Local regulations for electrical installations must be observed at all times.

Further, the following basic principles must be observed:

- The power supply 9 .. 30 VDC is to be provided by the customer. It must be stable, low noise voltage.
- Only voltages complying with the local regulations for low voltage may be used as power supply and on the galvanically separated current output.
- Because the unit has no main switch, a suitable disconnection device (switch, plug) must be installed near the power supply.
- If faults cannot be remedied, the unit must be put out of operation and protected against inadvertent operation.

5.2. Installation of the PhaseGuard

Connecting the photometer



An 8-pin connector of type M12x1 with A-coding is used. A screened device cable must be used. The connector assignment looks like the following:

Description	Connector pin (male)	Wire color for device cable (art. no. 120444)	Remarks
GND supply	2	white	
Supply 9 .. 30 VDC	1	brown	
RS 485 A	7	blue	Serial interface for SICON (M)
RS 485 B	5	gray	Alternative: initiate zero calibration → Reference Manual
Digital output 1 (alarm)	6	pink	Open collector to GND
Digital output 2 (limit)	4	yellow	Open collector to GND
Current output +	8	red	Max. 35 V to ground Max. 500 Ω burden
Current output -	3	green	Factory setting: 0 .. 100%
Shielding		Screen	Must be connected to ground

Cross-section specifications for longer distances

The maximum distance (X) between SICON or a customer-side system (3) and the junction box (2) depends on the power supply and the cross-section in use:

CROSS-SECTION	MAX. DISTANCE FOR 12 VDC (WITH PROFIBUS)	MAX. DISTANCE FOR 24 VDC (WITH PROFIBUS)	REMARKS
[mm²]	[m]	[m]	
0.14	40 (20)	150 (100)	
0.20	60 (30)	250 (150)	Standard version
0.34	100 (50)	400 (250)	
0.50	140 (70)	600 (350)	
0.75	210 (110)	800 (500)	
1.00	280 (140)	800 (700)	
1.50	400 (200)	800 (800)	

Cable structure

Paired cable, complete copper-braided shielding, impedance 100-165 Ω, capacitance < 60 pF/m



5.3. Installation of the SICON control unit, field bus

Installation of the optional SICON control unit as well as installation and commissioning of the field bus interfaces are described in the Reference Manual.

6. Initial start-up

6.1. Commissioning procedure



	WORKSTEP	PROCEDURE
1.	Check mounting and installation.	Ensure that the photometer and components are correctly mounted and connected. → Section 4, 5
2.	Connect power supply to the photometer.	→ Section 5
3.	Connect photometer to PC.	<p>3.1: Remove cover (arrow) of the USB interface.</p> <div style="border: 1px solid black; padding: 5px;"> <p> Damage to the photometer caused by moisture inside the instrument: The cover to the USB interface may be removed only under dry conditions.</p> </div>  <p>3.2: Connect the PhaseGuard via USB cable to the PC. The PhaseGuard registers itself as a removable disk in the Windows operating system.</p> <p>3.3: Depending on the Windows configuration, a window opens automatically with the removable removal disk or you have to open the removal disk manually using Windows Explorer.</p> <p>The following files appear:</p> <p>Info.txt: information data about the PhaseGuard, e.g. serial number, software version, hours of operation.</p> <p>Config.txt: configuration file.</p> <p>Zero.txt: file with which a zero calibration can be initiated.</p>
4.	Configure. The following functions can be set as described in 4.1 to 4.4:	<p>4.1: Open the Config.txt file.</p> <p>4.2: Change the desired parameter. Enter number after "=".</p> <p>e.g. 0 for German or 1 for English</p>

	WORKSTEP	PROCEDURE
	<p>Language: 0: German, 1: English – setting the operating language</p> <p>Current source channel: 0: Turb, 1: Grad, Default = 0 Setting the source for the current output</p> <p>Current from: 0.000 Setting the lower value of the current range</p> <p>Current to: 100 Setting the upper value of the current range</p> <p>Limit source channel: 0: Turb, 1: Grad, Default = 0 Setting the source for limit formation</p> <p>Limits mode: 0: inactive; 1: exceeded; 2: undershot; default = 0</p> <p>Upper limits: 0.000 Enter limits with upper threshold.</p> <p>Lower limits: 0.000 Enter limits with lower threshold.</p> <p>Integration: 0 s Integration time of the measuring value of 0 .. 60000 seconds.</p> <p>Output 1 invert: 0: No, 1: Yes Invert: inverts output 1 (alarm)</p> <p>Output 2 invert: 0: No, 1: Yes Invert: inverts output 2 (limit)</p> <p>Factory set.: 0: No; 1: Yes With Yes the factory setting is loaded.</p>	<p>4.3: Close the file after the entry. Changes are saved automatically. The window of the removable disk disappears and then reappears in a moment.</p> <hr/> <p>4.4: If the configuration is successful, the file Config.OK appears.</p> <p>If the configuration is not successful, the file Config.ERR appears.</p> <p> The configuration may fail if the entered values are not within the permitted range or if text areas have been deleted or changed. If the configuration is faulty, the file Config.txt is automatically generated again and the procedure can be repeated.</p>
5.	Carry out zero calibration as described in Section 6.2.	
6.	Complete procedure.	After successfully setting all parameters, remove the USB connector from the instrument and screw on the cover again.



If malfunctions occur, please refer to the Reference Manual.

6.2. Perform zero calibration



	WORKSTEP	PROCEDURE
1.	Prepare system for zero calibration.	<p>1.1: Prepare photometer as described in Section 6.1.</p> <p>1.2a: Zero calibration in the sample line: If clean, bubble-free water is in the sample line (e.g. after CIP cleaning), a zero calibration can be performed without disassembling the instrument. If this is not possible, proceed according to step 1.2b.</p> <p>1.2b: Zero calibration outside the sample line:</p> <div style="border: 1px solid black; padding: 5px; margin: 10px 0;"> <p>⚠ Remove photometer without previously emptying the sample line. The photometer can be removed from a line only when the line is completely empty. If this is not the case, flooding and damage to equipment as well as bodily injury may occur.</p> </div> <p>1. Ensure that the sample line is empty.</p> <p>2. Remove the photometer (1) from the sample line and submerge the measurement opening (2) in clean, bubble-free water.</p> <p>i The measurement opening (2) must be completely submerged in the water and no external light is allowed to penetrate. If necessary, cover with a black cloth or use a non-transparent container (3). A transparent container is used here only for illustrative purposes.</p> <div style="text-align: center; margin: 10px 0;"> </div> <p> 1 Photometer 2 Measurement opening (completely in the water) 3 Container with clean water </p>

	WORKSTEP	PROCEDURE
2.	Perform zero calibration.	2.1: Open the “Zero.txt” file.
		2.2: Enter the number 1 after the “=” symbol. 0 for Adjustment no or 1 for Adjustment yes
		2.3: After entry, close the file to save the changes. Changes are saved automatically. The window of the removable disk disappears and then reappears in a moment.
		2.4: If the adjustment is successful, the file Zero.OK appears. If the configuration is not successful, the file Zero.ERR appears. In this case, repeat adjustment and check the points in the following list one after the other: <ul style="list-style-type: none"> ■ Soiled window on the sensor head. → Reference Manual ■ Air bubbles in the water. ■ Soiled optics in the instrument. → Reference Manual  If the check was not successfully completed, contact your country representative. → Section 10
3.	Complete procedure.	Put the instrument in its initial state.



If malfunctions occur, please refer to the Reference Manual.

7. Operation

The PhaseGuard can be operated with a SICON (control unit). Handling and parameterization of the menu functions are described in detail in the Reference Manual.

8. Servicing



It is absolutely necessary to observe relevant information when performing servicing duties:

- The instrument must never be operated when the housing is removed.
- The instrument may be opened only by trained personnel.
- The instrument may be opened only in dry conditions.



The servicing duties are described in detail in the Reference Manual.

8.1. Servicing schedule

Recommended servicing duties

WHEN	WHO	WHAT	PURPOSE
Annually or if HUMIDITY warning	Operator	Change desiccant → Section 8.2	Obligatory measure for maintaining the measuring accuracy and for protecting the electronics. Interval depends on operating and ambient conditions.
Annually or as needed	Operator	Clean the sensor head → Section 8.3	Obligatory measure for maintaining measuring accuracy. Interval depends on the sample.
Annually or as needed	Operator	Zero calibration of the photometer → Section 6.2	Maintain measuring accuracy.
As needed	Operator	Replace gaskets on Varivent® housing → Section 8.4	For maintaining sealing on the process line.
Every 10 years or as needed	Operator	Replace the battery in the SICON → Referencehandbook	Obligatory measure for maintaining functional efficiency.

Table 1: Servicing schedule

8.2. Replacing the desiccant





Condensation on electronic and optical components

Do not open the photometer if a cold medium is flowing through the lines. Perform this work procedure only when the system is in a sterilization phase or the medium is at least at room temperature. Similarly, if the instrument is removed from the line for service work, make sure that the instrument is at least at room temperature before it is opened.



- If the desiccant has to be frequently replaced, the sealing of the instrument should be checked by a SIGRIST service technician.
- The following servicing duty is identical for the PhaseGuard standard version and for PhaseGuard with integrated field bus interface (Modbus RTU / Profibus DP).



	WORKSTEP	PROCEDURE
1	Remove cover of electronic part.	Turn cover counter-clockwise and remove electronic component. 
2	Replace desiccant.	2.1: Remove old desiccant bag. 2.2: Embed the new desiccant bag behind the connection cable. 
3	Mount cover.	Screw the cover onto the electronic component again immediately.

8.3. Cleaning the sensor head



Danger when removing the instrument if the sample line has not been previously emptied.
 The photometer may be removed from a line only when the line is completely empty. If this is not the case, flooding and damage to equipment as well as bodily injury may occur.

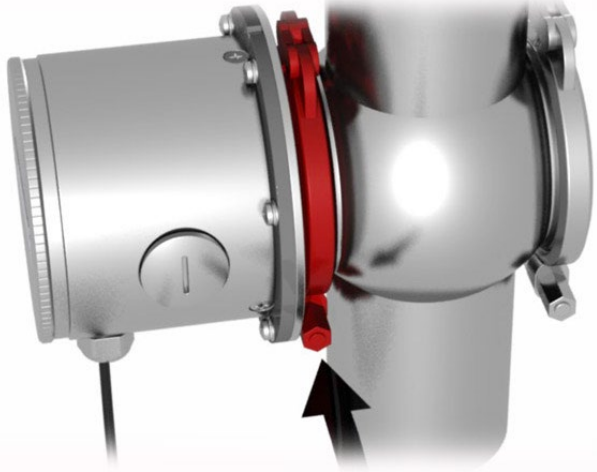

	WORKSTEP	PROCEDURE
1	Empty sample line.	Make sure the line is empty.
2	Put the system into a safe state and remove the instrument from the line.	<p>! Danger when removing the photometer if the sample line has not been previously emptied: The photometer may be removed from a line only when the line is completely empty. If this is not the case, flooding and damage to equipment as well as bodily injury may occur.</p> <p>2.1: Release lock clamp that fastens the photometer.</p>  <p>2.2: Remove the instrument from the line and place it on a solid surface with the sensor head up.</p>

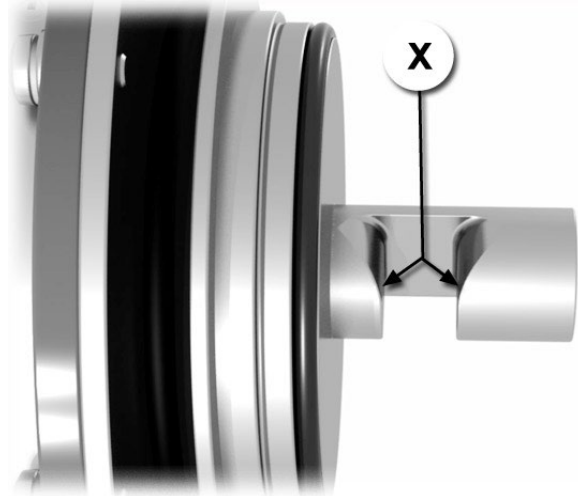
	WORKSTEP	PROCEDURE
3	Cleaning the sensor head.	<p>⚠ Damage to the sensor head due to improper handling. No other cleaning methods or other cleaning agents should be used.</p> <p>Clean the two windows on the sensor head (X) with a mild, non-abrasive cleaning agent (e.g. alcohol or soap) and a soft, lint-free cloth.</p> 
4	Re-mount the instrument in the sample line.	→ Instruction Manual

8.4. Replacing gasket of the in-line housing and blanking plate



CAUTION!

Danger when removing the instrument if the sample line has not been previously emptied.

The photometer may be removed from a line only when the line is completely empty. If this is not the case, flooding and damage to equipment as well as bodily injury may occur.

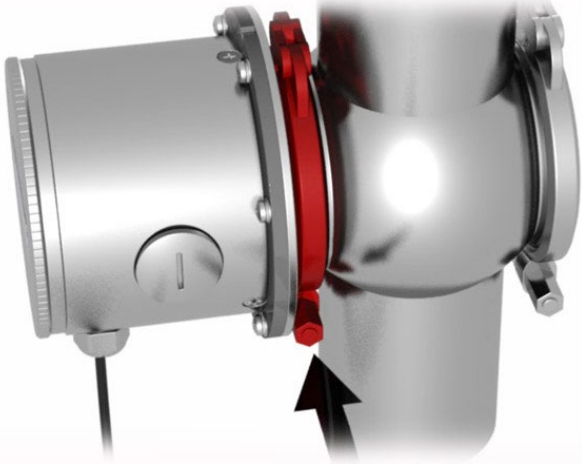
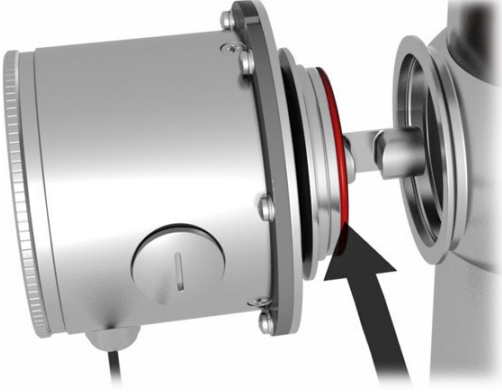

	WORKSTEP	PROCEDURE
1	Empty sample line.	Ensure that the sample line is empty.
2	Put the system into a safe state and remove the instrument from the line.	<p>! Danger when removing the photometer if the sample line has not been previously emptied: The photometer may be removed from a line only when the line is completely empty. If this is not the case, flooding and damage to equipment as well as bodily injury may occur.</p> <p>2.1: Release lock clamp that fastens the photometer.</p>  <p>2.2: Remove photometer from the line and replace the old gasket (arrow) with a new gasket.</p> 

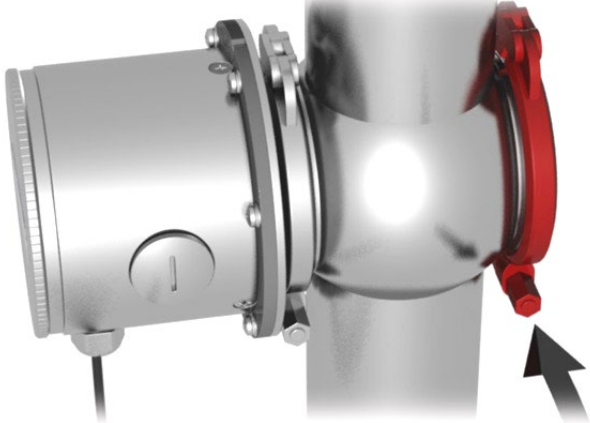
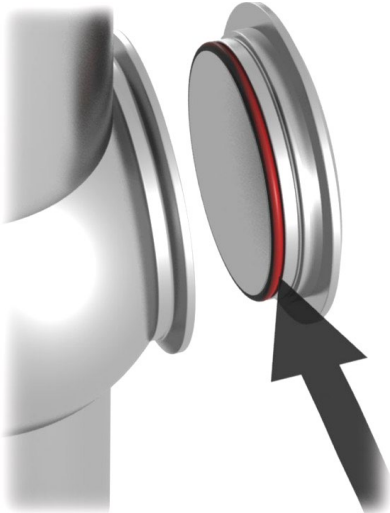
	WORKSTEP	PROCEDURE
3	Remove the blanking plate from the sample line.	<p>3.1: Remove lock clamp for fastening the blanking plate.</p>  <p>3.2: Remove blanking plate and replace the old gasket (arrow) with a new one.</p> 
4	Re-mount photometer and blanking plate.	Re-mount the photometer and the blanking plate in the sample line and put into operation as described in the Instruction Manual.

9. Troubleshooting



The following measures can be used for troubleshooting. A SICON control unit or web browser is required to analyze warning and error messages; this is described in detail in the → Reference Manual.

DETECTABLE FAULT	MEASURES
Occurrence of a warning or error message	Analyze this message as described in the Reference Manual or take the following steps.
The measuring value is wrong	<ul style="list-style-type: none"> ■ Make sure that the medium in the product line corresponds to the operating conditions. → Section 2.2 ■ Check whether the photometer is correctly mounted. → Section 4 ■ Ensure that the maintenance duties have been performed according to the maintenance schedule. → Section 8 ■ Perform a zero calibration of the photometer. → Section 6.2 ■ Check the dry chamber in the housing. → Reference Manual ■ Clean the sensor head. → Reference Manual
No display or indication (only with SICON)	<ul style="list-style-type: none"> ■ Check whether the service voltage is correctly connected to the SICON. → Reference Manual

If the listed measures do not result in the desired results, please consult with customer service. → Section 10

10. Customer service information

Should you have any questions, please contact the responsible service center in your country or region. If this is not known, SIGRIST-PHOTOMETER AG customer service in Switzerland would be glad to provide you with a contact address.

A current list of all SIGRIST country representatives is available in the Internet at www.photometer.com.

Please have the following information ready when you contact a SIGRIST service point or customer service:

- The serial number of the PhaseGuard. → Section 2.1.7
- A description of instrument behavior and the work steps when the problem occurred.
- A description of what you did when trying to solve the problem yourself.
- The documentation of the third-party products you use in conjunction with the photometer or peripheral devices.

11. Decommissioning & storage





Life threatening voltage inside the instrument:
 Connecting electrical lines is extremely dangerous. Parts of the system can also be damaged. Local regulations for electrical installations must be observed at all times.



Remove photometer without previously emptying the sample line:
 The photometer can be removed from a line only when the line is completely empty. If this is not the case, flooding and damage to equipment as well as bodily injury may occur.

The aim of decommissioning is to prepare the photometer properly for storage and to conserve it during storage.



	WORKSTEP	REMARKS
1.	<p> Dangerous voltage inside the instrument: Connecting electrical lines is extremely dangerous. Parts of the system can also be damaged. Local regulations for electrical installations must be observed at all times.</p> <hr/> <p>Interrupt the power supply to the control unit and remove electrical connections.</p>	
2.	<p> Remove photometer without previously emptying the sample line: The photometer can be removed from a line only when the line is completely empty. If this is not the case, flooding and damage to equipment as well as bodily injury may occur.</p> <hr/> <p>Interrupt the flow rate through the sample line and then empty it. Remove the photometer from the sample line and clean the sensor head.</p>	→ Reference Manual
3.	Check the dry chamber of the instrument. Replace desiccant if necessary.	→ Reference Manual
4.	Disassemble the control unit.	→ Reference Manual
5.	Make sure that all covers are closed and all locks on the instrument and control unit are locked.	

Storage

There are no special requirements for storing the instruments. However, please note the following information:

- The photometer and the control unit contain electronic components. Storage for such components must fulfill the usual conditions. It is important to note that the storage temperature must be between -20 and +50°C.
- All components that come into contact with the sample during operation have to be dry and clean for a long period of time before being put into storage.
- The photometer, control unit and accessories must be protected from weather factors, condensing humidity, and aggressive gases.

12. Packaging & transport

The original packaging materials of the photometer should be used for packaging the photometer and its peripheral components if possible. If the original packaging is no longer available, note the following information:

- Before packaging the photometer, close the openings on the photometer with adhesive tape or plugs so that no packaging materials can enter the instrument.
- The photometer contains optical and electronic components. Make sure that the packaging protects the instrument from damaging impact during transport.
- Package all peripheral devices and accessory parts separately and label each part with the serial number (serial no. → Section 2.1.7). This prevents confusion and mix-ups later while also making it easier to identify parts.

When packaged in the way described above, the photometer and control unit can be transported by the usual shipping methods and in all positions.

13. Disposal



Disposal of the photometer and its peripheral devices is to be carried out in compliance with regional legal regulations.

The photometer and control unit have no environmentally damaging sources of radiation. The materials listed below should be disposed of or recycled as described in the following table:

CATEGORY	MATERIALS	DISPOSAL POSSIBILITIES
Packaging	Cardboard, paper	Reuse as packaging material, local disposal points, incineration plants
	Protective foils, polystyrene shells	Reuse as packaging material, recycling
Electronics	Printed circuit boards, electro-mechanical components	To be disposed of as electronic waste
Desiccant	Rubingel	Residual waste (chemically harmless)
Optics	Glass, sapphire	Recycling via centers for recycling glass and waste metal
Housing	Stainless steel	Waste metal disposal centers
	ABS	Incineration plants, garbage dumping site

Table 2: Materials and their disposal

14. Spare parts

The following table lists the spare parts and their article numbers. The detailed worksteps for replacing spare parts are described in the → Reference Manual.

ART. NO.	ARTICLE NAME	REMARKS
108247	O-ring EPDM 60 x 3, 75 shore A	Material EPDM, 60 x 3 mm
111391	Desiccant bag, 30 g	Sealed packaging, unlimited shelf life
112379	O-ring NBR 60 x 3, 70 shore A	Material Nitril/NBR, 60 x 3 mm
112698	O-ring FPM 60 x 3, 75 shore A	Material Viton/FPM, 60 x 3 mm
114446	O-ring FFPM 60 x 3, 80 shore A	Material FFPM, 60 x 3 mm
120444	Device cable 8-pole with connector	Length 10 m

Table 3: Spare parts and article numbers

15. Appendix

15.1. Dimension sheet PhaseGuard-MB

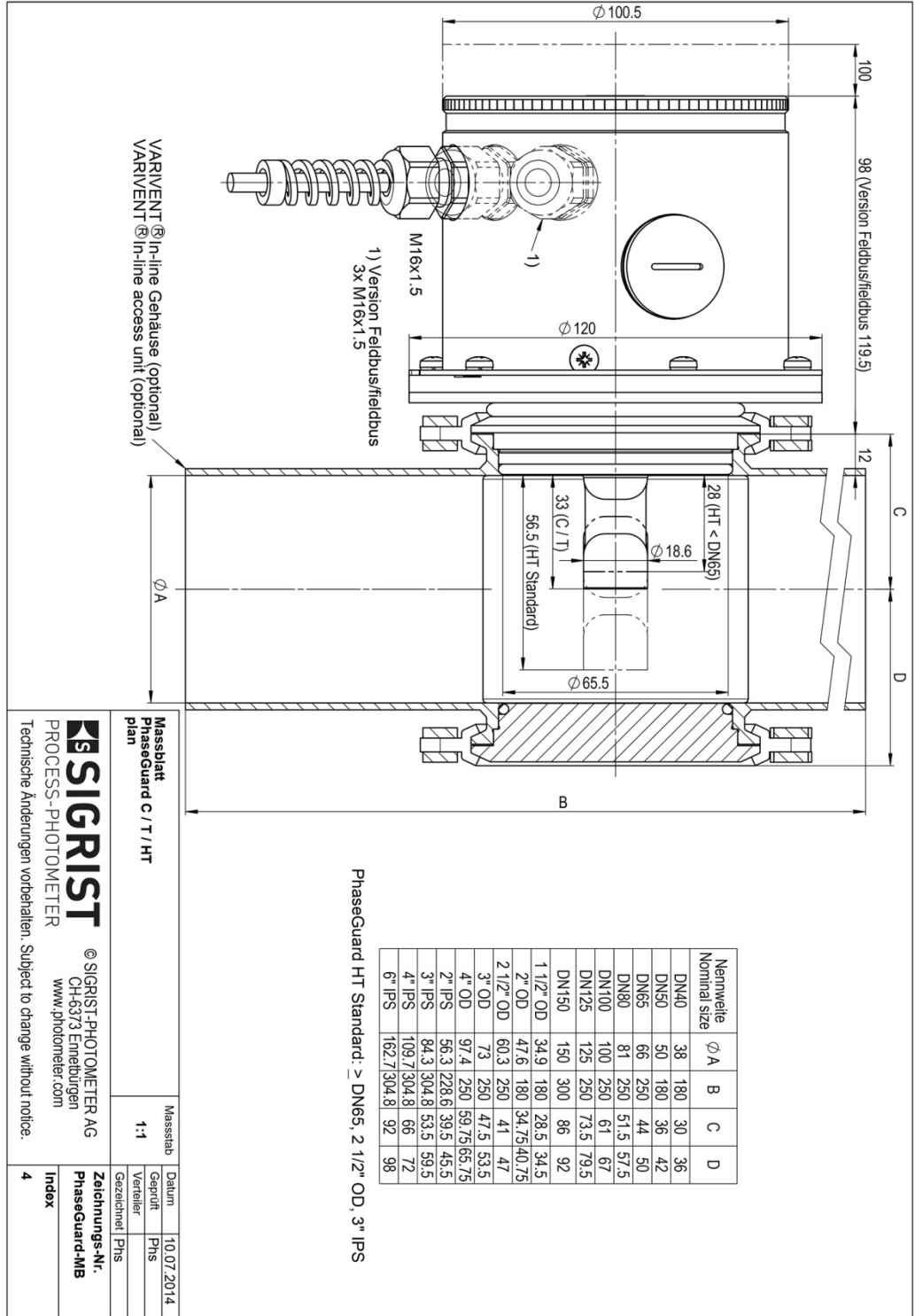

15.2. Overview of gaskets on the PhaseGuard

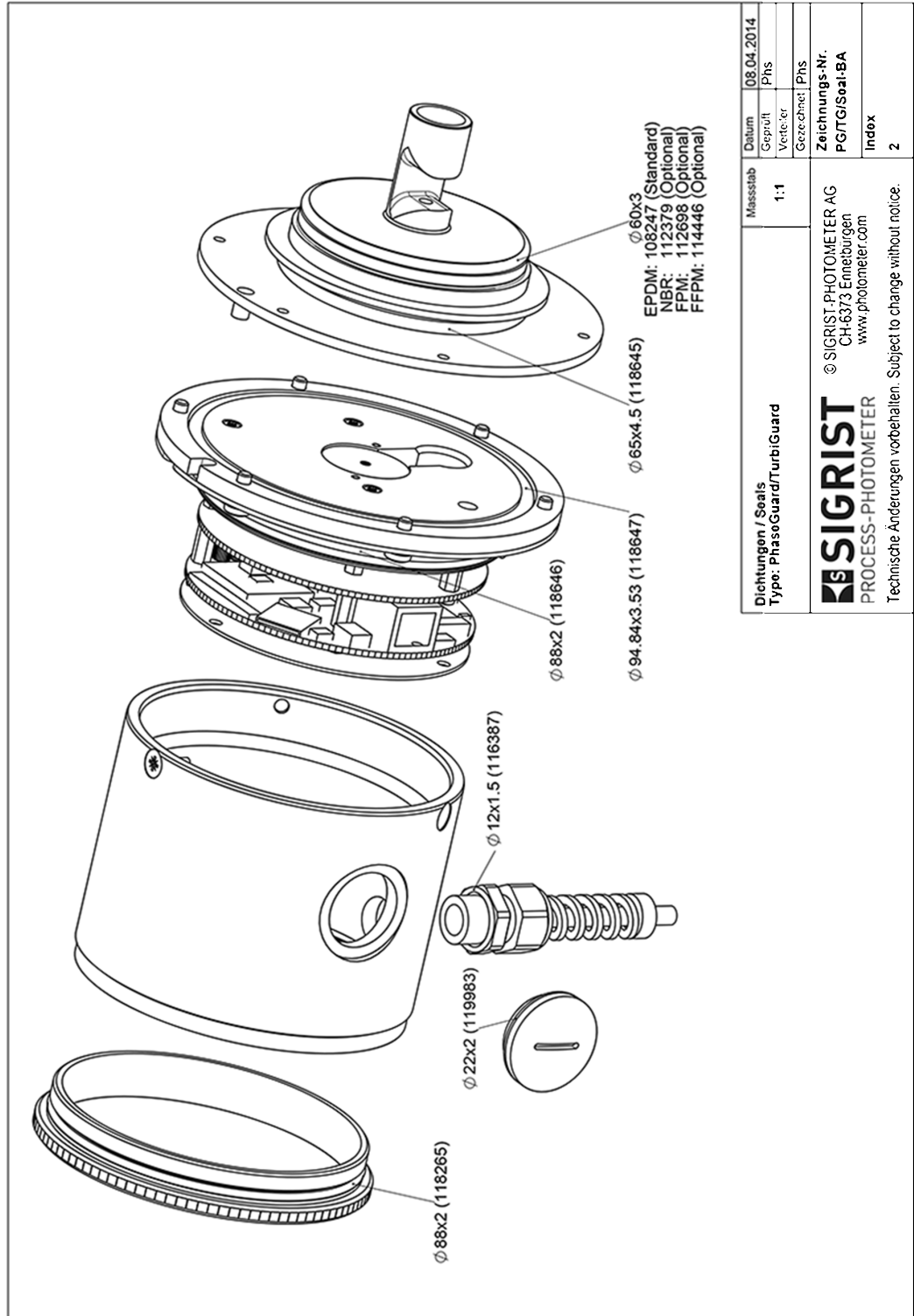

Dichtungen / Seals Type: PhaseGuard/TurbiGuard	Maßstab	Datum	08.04.2014
	1:1	Geprüft	Phs
 SIGRIST SIGRIST-PHOTOMETER AG CH-6373 Emmenbürgen www.photometer.com	Zeichnungs-Nr.	PGTG/Seal:BA	
	Index	2	

Technische Änderungen vorbehalten. Subject to change without notice.

15.3. PhaseGuard connection diagram

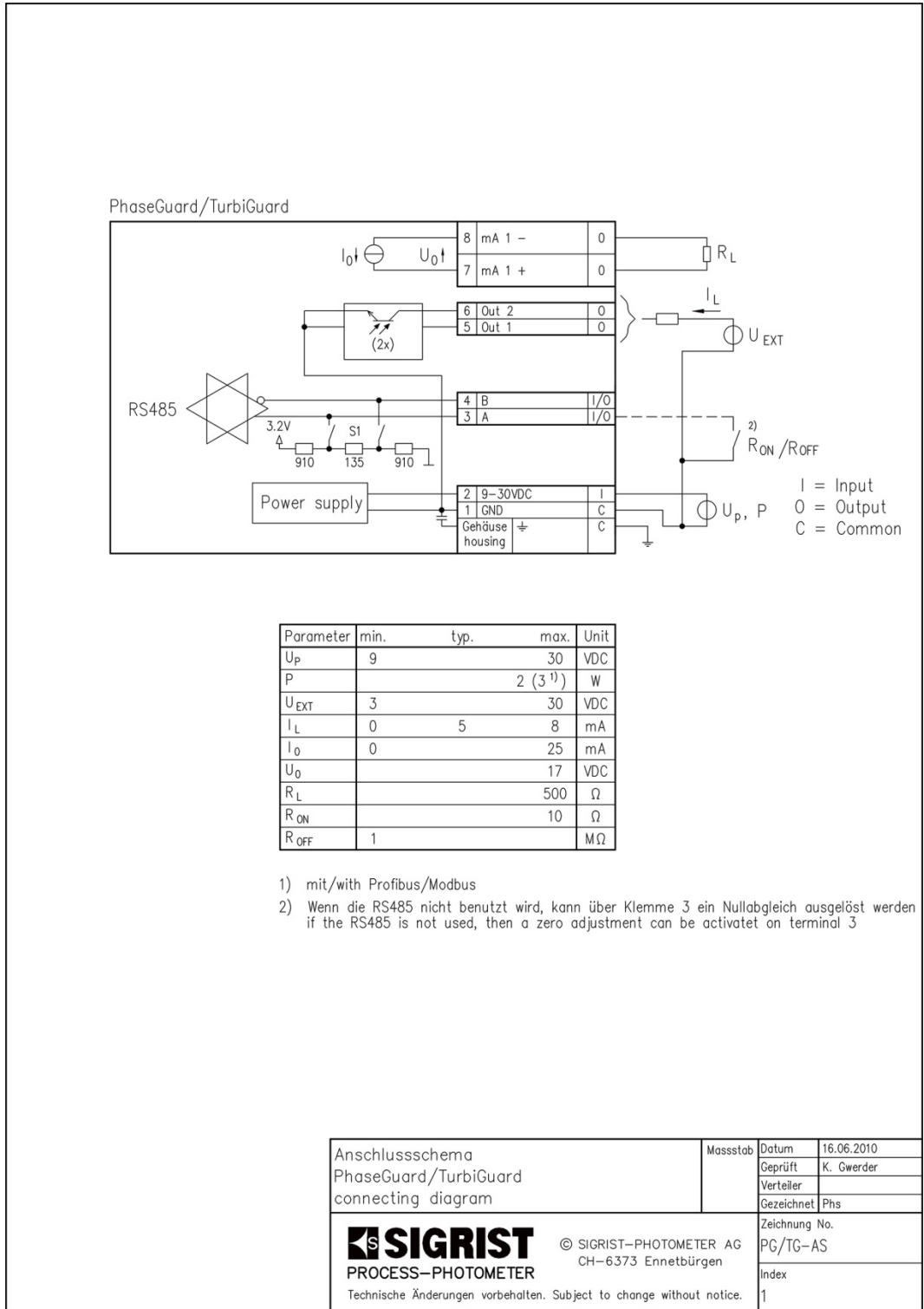

16. Index

A		M	
Article numbers.....	31	Mounting	14
B		Mounting position	14
Behavior in emergency	10	P	
C		Packaging	29
CE mark	4	Pictograms.....	2
Clean sensor head.....	23	Proper use	3
Commissioning	17	R	
Conformity of the product	4	Rating plate	5
Connections, length	16	Replacing gaskets	25
Cross-section.....	16	Residual risk.....	12
Customer service.....	27	S	
D		Scope of delivery.....	6
Dangers	4, 11	Service center	27
Decommissioning	28	Servicing duties.....	21
Desiccant	22	Servicing schedule.....	21
Desiccant, replace	22	Spare parts	31
Disposal	30	Storage.....	29
E		T	
EMC.....	4	Technical data.....	8
Environmental damage.....	30	Terminal junction box	16
EU, European Union	4	Terms, glossary	ii
Explanation of symbols.....	2	Transport.....	29
G		U	
Guidelines	4	Use restrictions	4
H		V	
Horizontal	13	Vertical	13
I		View of a measuring station	3
In-line housing	13	W	
Internet	27	Warning symbols on the instrument	12
L		Z	
Limits, definition.....	18	Zero calibration	19

SIGRIST-PHOTOMETER AG
Hofurlistrasse 1
CH-6373 Ennetbürgen
Switzerland

Tel.+41 41 624 54 54
Fax+41 41 624 54 55
info@photometer.com
www.photometer.com