

# INSTRUCTION MANUAL

## TurbiGuard



## In-line Turbidimeter

SIGRIST-PHOTOMETER AG  
Hofurlistrasse 1  
CH-6373 Ennetbürgen  
Switzerland

Tel. +41 41 624 54 54  
Fax +41 41 624 54 55  
info@photometer.com  
www.photometer.com

# Content

1.	Notes to the user .....	1
1.1.	General information .....	1
1.2.	Explanation of symbols .....	2
2.	Instrument description .....	3
2.1.	General information about TurbiGuard .....	3
2.2.	Technical data .....	8
3.	General safety pointers .....	9
3.1.	Behavior in emergency .....	9
3.2.	Dangers when using properly .....	10
3.3.	Residual risk .....	11
3.4.	Warning and danger symbols on the instrument .....	11
4.	Mechanical mounting .....	12
5.	Electrical installation .....	14
5.1.	Safety pointers for the electrical installation .....	14
5.2.	Installation of the TurbiGuard .....	15
5.3.	Installation of the SICON control unit, field bus .....	16
6.	Initial start-up .....	17
6.1.	Commissioning procedure .....	17
6.2.	Perform zero calibration .....	19
6.3.	Setting the current output .....	21
6.4.	Setting the limits .....	22
7.	Operation .....	22
8.	Servicing .....	23
9.	Troubleshooting .....	24
10.	Customer service information .....	24
11.	Decommissioning & storage .....	25
12.	Packaging & transport .....	26
13.	Disposal .....	27
14.	Spare parts .....	27
15.	Appendix .....	28
15.1.	Mounting dimensional drawing TURBIGUARD-MB .....	28
15.2.	Overview of TurbiGuard gaskets .....	29
15.3.	Connection diagram .....	30
1.	Index .....	31

# Terms used in this document (glossary)

Please refer to our website for specialist terms: [www.photometer.com](http://www.photometer.com)

# 1. Notes to the user

## 1.1. General information

### Purpose of the Instruction Manual

This Instruction Manual provides the user with the most important information up to and including commissioning. Information such as operation, servicing, troubleshooting and more are described in detail in the Reference Manual.

### Target group

The Instruction Manual is intended for all persons who are responsible for mounting, installing and commissioning the instrument.

### Additional documentation

DOC. NO.	TITLE	CONTENT
11029E	Reference Manual	More sophisticated menu functions and work steps for advanced users. This document can be downloaded by registered users from <a href="http://www.photometer.com">www.photometer.com</a> .
11019E	Data sheet	Descriptions and technical data about the photometer.
11052E	Service Manual	Repair and conversion instructions for service engineers.
11050DEF	Declaration of conformity	Compliance with the underlying directives and standards.

### Copyright regulations

This Instruction Manual has been written by SIGRIST PHOTOMETER AG. Copying or modifying the content or giving this document to third parties is permitted only with the express written consent of SIGRIST-PHOTOMETER AG.

### Storage location of the Instruction Manual

The INSTRUCTION MANUAL is a component of the product and should always be close at hand.

The most recent version (in color) can be downloaded at [www.photometer.com](http://www.photometer.com) (necessary to register the first time).

It can also be ordered from the representative in your country. → Section 10

## 1.2. Explanation of symbols

### Danger symbols

Below is an explanation of all **danger symbols** that occur in this Instruction Manual.



**DANGER!**

**Danger due to electrical shock that may result in serious bodily injury or death.**

Non-observance of this danger warning may lead to electrical shocks and death.



**DANGER OF EXPLOSION!**

**Explosion hazard with possible serious bodily injury or death.**

Non-observance of this notice may cause explosions resulting in serious material damage and death.



**WARNING!**

**Warning about bodily injury or hazards to health with long-term effects.**

Non-observance of this warning may lead to injuries with possible long-term effects.



**CAUTION!**

**Notice about possible material damage.**

Non-observance of this notice may cause material damage to the instrument and its peripherals.

### Pictograms

Below is an explanation of all **pictograms** that occur in this Instruction Manual.



Additional information about the current topic.



Practical procedures when working with the photometer and control unit.



Work on the PC.

## 2. Instrument description

### 2.1. General information about TurbiGuard

#### 2.1.1. View of a measuring station

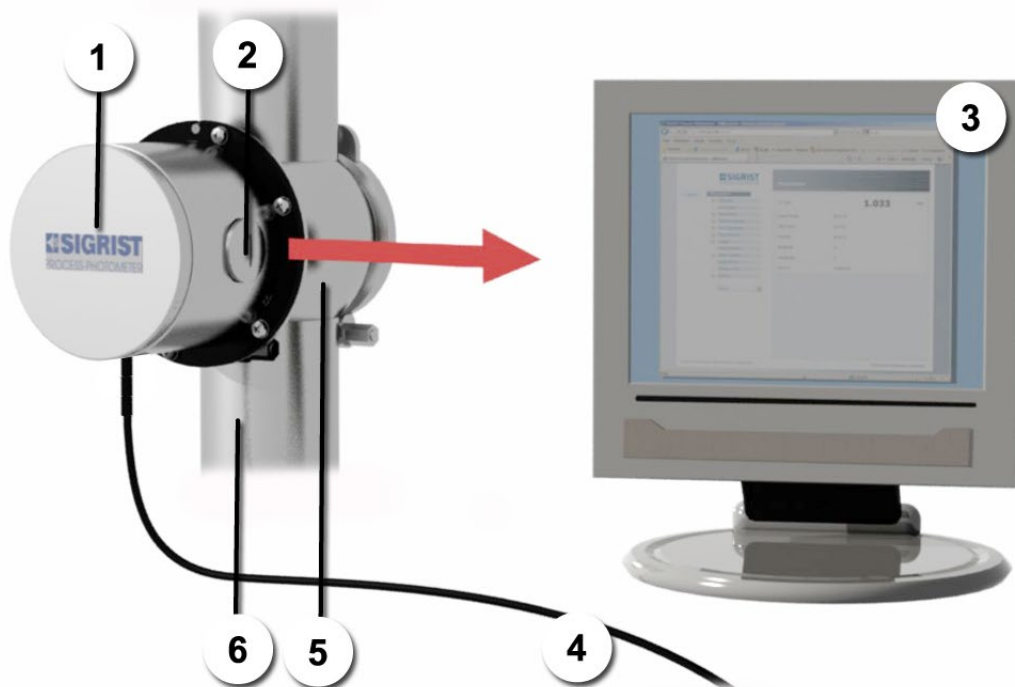

Figure 1: TurbiGuard overview

①	TurbiGuard photometer	④	Connection cable between photometer and customer-side control system and power supply
②	Ethernet interface	⑤	Varivent® in-line housing or compatible housing (optional)
③	PC with web browser	⑥	Sample line

### 2.1.2. Proper use

The TurbiGuard and its peripheral equipment are designed to measure turbidity in liquids and gasses.

Possible areas of application:

- Food and beverage industry
- Milk processing industry
- Chemical and pharmaceutical industry

### 2.1.3. User requirements

- The instrument may be operated only by trained technical personnel.
- The instrument may be operated only by persons who are familiar with the content of the Instruction Manual and Reference Manual.

### 2.1.4. Conformity

Current technological principles were followed in designing and manufacturing the photometer. They comply with the usual guidelines concerning duty to take care and safety.

The system meets the requirements applicable within the European Union (EU) for electromagnetic compatibility (EMC) and low voltage directives (LVD) and has the CE mark.

Please refer to the separate declaration of conformity for details (document 11050DEF) .



**DANGER OF  
EXPLOSION!**

### 2.1.5. Use restrictions

#### **Explosion hazard during operation in an inappropriate environment.**

Use in explosion hazardous areas may cause explosions that could be lethal to persons in the vicinity.

- It is not permitted to operate the instrument in explosion hazardous areas or rooms.
- It is not permitted to use the instrument with explosive media.



**DANGER!**

#### **Danger during operation with inappropriate medium.**

The use of too hot or aggressive media may cause leakage that could be lethal to persons in the vicinity.

It is not permitted to use the measuring instrument for applications in which parts of the instrument or the whole device can be affected by the medium. Parts which contact the medium: Stainless steel, sapphire, gaskets.



**DANGER!**

## 2.1.6. Dangers when not used properly

### Operation when not used properly.

Improper use can cause injuries to persons, process-related consequential damage and damage to the photometer and its peripherals.

In the following cases the manufacturer cannot guarantee the protection of persons and the instrument and therefore assumes no legal responsibility:

- If the instrument is used in a way not included in the described area of application.
- If the instrument is not properly mounted.
- If the instrument is not installed and operated in accordance with the Instruction Manual.
- If the instrument has been operated with accessories which SIGRIST-PHOTOMETER AG has not expressly recommended.
- If changes to the instrument have been performed improperly.
- If the instrument has not been operated within the specifications, in particular concerning pressure and temperature.

### 2.1.7. Identification of the TurbiGuard

The photometer displays the following rating plate:





Figure 2: TurbiGuard rating plate





①	Manufacturer	⑥	Service voltage
②	Country of origin	⑦	Frequency range
③	Product name	⑧	Power
④	Serial number	⑨	Observe Instruction Manual.
⑤	Date of manufacture	⑩	Disposal information → Section 13

## 2.1.8. Scope of delivery and accessories

### Scope of delivery

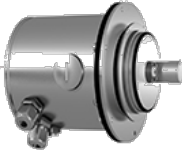
PCS.	ART. NO.	NAME	VIEW	VARIANT
1	118674	TurbiGuard Photometer for measuring medium to high turbidity		
1	20012	Instruction Manual		German 11028D English 11028E French 11028F
1	118731	Ethernet cable		

### Optional accessories:

PCS.	ART. NO.	NAME	VIEW	VARIANT
1	118695	TurbiGuard with integrated fieldbus interface, recognizable by the larger housing, the two cable penetrations and the M12 connector		Profibus DP
	118696			RTU Modbus
1	118342	SICON control unit		
1	119040	SICON M multichannel control unit		
1	120444	Device cable, 8-pin, 10 m with connector		
1	Various	Varivent® in-line housing		Various nominal widths
1	118740	Blanking plate uncoated		
1	20012	Reference Manual as PDF		German 11029D English 11029E

## 2.2. Technical data

TURBIDITY MEASUREMENT	VALUES
Measuring principle	Absorption at 880 nm
Measurement span	0..2000 EBC (0...8000NTU) Calibration up to 1000 EBC (4000 NTU)
Measuring ranges	0 .. 100 EBC (0 .. 400 NTU) 0 .. 1000 EBC (0 .. 4000 NTU)
Sample temperature	-10 .. +100°C 120°C max. 2 h
Ambient temperature	-10 .. +50°C
Pressure	1 MPa (10 bar) / 100°C
Resolution	0.5 EBC / 2 NTU
Reproducibility (2 instruments with same formazine)	<ul style="list-style-type: none"> <li>■ 0 .. 100 EBC: ± 2% (full scale)</li> <li>■ 0 .. 1000 EBC: ± 3% (full scale)</li> <li>■ 0 .. 2000 EBC: ± 5% (full scale)</li> </ul>
Warm-up time	< 3 min
Repeatability (2 measurements with 1 instrument)	0.5 EBC ± 0.25% (full scale)
Temperature stability	±0.05% / K (full scale)
Reaction time	< 0.3 s at 0 seconds integration time (step response → limit switch)
Ambient humidity:	0 ..100% relative humidity
Path length	10 mm
Outputs	<ul style="list-style-type: none"> <li>■ 1 x 0/4 .. 20 mA, galvanically separated up to max. 35 VDC relative to ground and max. 500 Ω burden</li> <li>■ 2 x switching transistor with open collector</li> </ul>
Interfaces	<ul style="list-style-type: none"> <li>■ Ethernet for operation/configuration via web browser</li> <li>■ Modbus RTU / Profibus DP field interfaces (both optional)</li> <li>■ Optional SICON control unit</li> </ul>

PHOTOMETER	VALUES
Service voltage	9 .. 30 VDC, 2 W (3 W with Profibus DP)
Material	<ul style="list-style-type: none"> <li>■ Housing: stainless steel 1.4301 or 1.4307</li> <li>■ Sensor head stainless steel 1.4404 or better</li> </ul>
Window	Sapphire
Weight	<ul style="list-style-type: none"> <li>■ TurbiGuard approx. 2.1 kg</li> <li>■ TurbiGuard with fieldbus approx. 2.5 kg</li> </ul>
Dimensions	Ø120 x 143 mm (164.5 with interface card) Detailed dimension drawing: TURBIGUARD-MB → Section 15
Pipe connections	Min. DN 40 Varivent® or compatible
Protection class	IP66

## 3. General safety pointers

### 3.1. Behavior in emergency



**Behavior in emergency:**

SIGRIST-PHOTOMETER AG instruments have no on/off switch. This is installed customer-side. Before commissioning, clarify the following points:

- Position of the on/off switch and the way it works.
- Where and how the sample supply can be stopped.
- Who the responsible authorities are.

**PROCEDURE IN AN EMERGENCY!**

	MEASURE	NOTES
1.	Interrupt the service voltage to the measuring station.	
2.	Interrupt sample supply.	
3.	Secure emergency location.	
4.	Notify responsible institution.	

## 3.2. Dangers when using properly



**DANGER!**

### **Electrical shock due to damaged instrument or cabling.**

Touching damaged cables may lead to electrical shocks with lethal consequences.

- The instrument may be operated only when the cables are undamaged.
- The instrument may be operated only if it has been properly installed or repaired.



**DANGER!**

### **Dangerous voltage inside the instrument due to galvanically separated current output.**

Touching the galvanically isolated current output may lead to electrical shocks with lethal consequences.

- The instrument must never be operated when the housing is removed.
- The instrument may be opened only by trained personnel.



**DANGER!**

### **Bodily injury due to escaping sample liquid.**

Contact with the medium may lead to burns, caustic irritations or poisoning with lethal consequences.

- The instrument must never be connected to leaking sample lines and operated.
- The local clothing regulations must be observed during operation.
- The local safety precautions must be observed during operation.



**WARNING!**

### **Damage due to incorrect service voltage.**

If the instrument is connected to an incorrect service voltage, it can be damaged.

- The instrument may be connected only to voltage sources as specified on the rating plate.



**CAUTION!**

### **Damage to the instrument caused by humidity or condensation entering the instrument when it is opened:**

If moisture enters the instrument, it can be damaged.

- Work may be performed on the instrument only in its warm state (condensation of moisture).
- The instrument may be opened only under dry conditions (e.g. remove cover to the Ethernet interface).



**CAUTION!**

### **Use of aggressive chemicals.**

The use of aggressive cleaning agents can destroy surfaces on the instrument that are relevant to measurement.

- Do not use aggressive chemicals or cleaning agents when cleaning.
- Thoroughly clean the instrument with a neutral cleaning agent if it has come into contact with aggressive chemicals.



**CAUTION!**

### **If the instrument changes hands, always include the Instruction Manual.**

If the Instruction Manual is lost, you can request a replacement.

Registered users can download the current version at: [www.photometer.com](http://www.photometer.com).

### 3.3. Residual risk



**DANGER!**

**During operation with hot or dangerous media, the possibility of leakage cannot be completely excluded.**

Contact with the medium may lead to burns, caustic irritations or poisoning with lethal consequences.

- The operator is responsible for using the instrument for this purpose.
- The operator must ensure that additional protection measures such as safety clothing and similar items are available and are put to use.
- To avoid faulty measurement values as much as possible, the maintenance duties must be carried out according to the servicing schedule.
- Evaluate digital output warnings and error messages to recognize them.

### 3.4. Warning and danger symbols on the instrument



**CAUTION!**

**There are no warning or danger symbols on the TurbiGuard.**

Users must ensure that they observe the safety measures as specified in the Instruction Manual when working with the photometer and its peripheral equipment at all times.

The following sections must be internalized:

- Section 1.2 "Explanation of symbols"
- Section 3 "Dangers when using properly"
- Section 2.1.6 "Dangers when not used properly"
- Observe local safety pointers when performing the described procedures.

## 4. Mechanical mounting

The instrument can be installed in horizontal or vertical sample lines using the standards-compliant in-line housing.



The mounting dimensional drawing (TURBIGUARD-MB) provides detailed information about the dimensions. Section 15

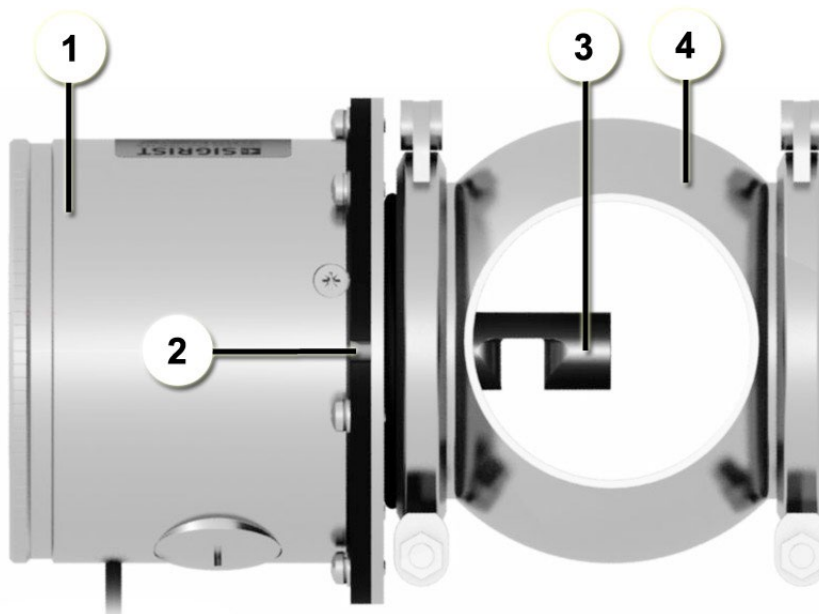

Figure 3: Position of the sensor in horizontal mounting

①	Photometer	③	Sensor with measurement opening pointing downward
②	Centering pin on the instrument	④	Varivent® sample line



**Basics of mounting the photometer**

- The photometer must be mounted in the line at least 0.5 m away from sight glasses and other unwanted light sources.
- In the vertical mounting position, the centering pin (2, Figure 3) must point upward (X, Figure 4).
- In the horizontal mounting position, the centering pin (2, Figure 3) must point to the right (Y, Figure 4).

Mounting position of the photometer:

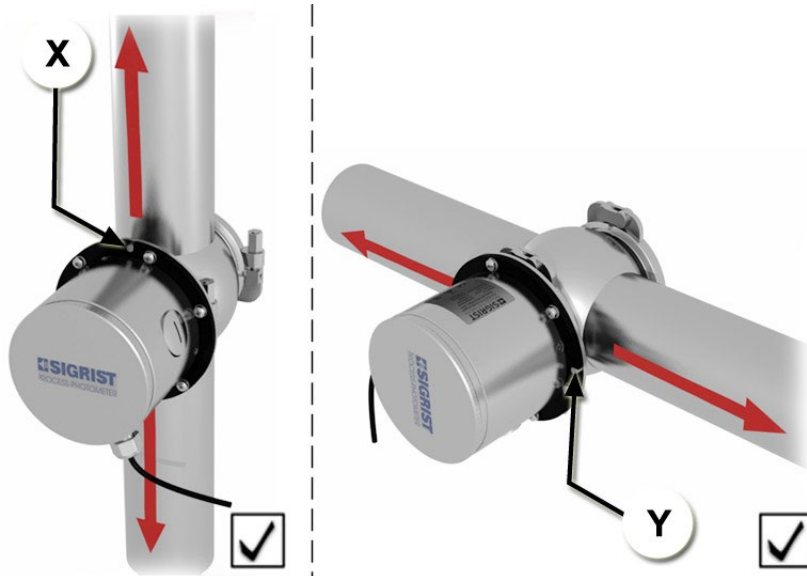

Figure 4: Correct installation in the vertical or horizontal sample lines



Figure 5: Incorrect mounting position

## 5. Electrical installation

### 5.1. Safety pointers for the electrical installation

**Dangerous voltage inside the instrument:**

Connecting electrical lines can be life threatening. Parts of the system can also be damaged. Local regulations for electrical installations must be observed at all times.

Further, the following basic principles must be observed:

- The service voltage 9 .. 30 VDC is to be provided by the customer. It must be a stable, low noise voltage.
- Only voltages complying with the local regulations for low voltage may be used as power supply and on the galvanically separated current output.
- Because the unit has no main switch, a suitable disconnection device (switch, plug) must be installed near the power supply.
- If faults cannot be remedied, the unit must be taken out of operation and protected against inadvertent operation.

## 5.2. Installation of the TurbiGuard

Connecting the  
photometer



An 8-pin connector of type M12 x 1 with A-coding is used. A screened device cable must be used. The connector assignment looks like the following:

Description	Connector pin (male)	Wire color for device cable (art. no. 120444)	Remarks
GND supply	1	white	
Supply 9 .. 30 VDC	2	brown	
RS 485 A	7	blue	Serial interface for SICON (M)
RS 485 B	5	gray	Alternative: initiate zero calibration → Reference Manual
Digital output 1 (alarm)	6	pink	Open collector to GND
Digital output 2 (limit)	4	yellow	Open collector to GND
Current output +	8	red	Max. 35 V to ground Max. 500 Ω burden
Current output -	3	green	Factory setting: 0 .. 1000 EBC
Shielding		Screen	Must be connected to ground

**Cross section specifications for longer distances**

The maximum distance (X) depends on the service voltage and the cross section in use:

<b>CROSS SECTION</b>	<b>MAX. DISTANCE FOR 12 VDC (WITH PROFIBUS)</b>	<b>MAX. DISTANCE FOR 24 VDC (WITH PROFIBUS)</b>	<b>REMARKS</b>
<b>[mm<sup>2</sup>]</b>	<b>[m]</b>	<b>[m]</b>	
0.14	40 (20)	150 (100)	
0.20	60 (30)	250 (150)	Standard version
0.34	100 (50)	400 (250)	
0.50	140 (70)	600 (350)	
0.75	210 (110)	800 (500)	
1.00	280 (140)	800 (700)	
1.50	400 (200)	800 (800)	

**Cable structure**

Paired cable, complete copper-braided shielding, impedance 100-165Ω, capacitance < 60 pF/m

### 5.3. Installation of the SICON control unit, field bus



Installation of the optional SICON control unit as well as installation and commissioning of the field bus interfaces are both described in the Reference Manual.





## 6. Initial start-up

### 6.1. Commissioning procedure

The procedure described here is for direct Ethernet connections between a Windows XP PC with a standard configuration and the TurbiGuard. Please consult the Reference Manual for integration into a network.





	WORK STEP	PROCEDURE
1.	Check mounting and installation.	Ensure that the photometer and components are correctly mounted and connected. Section 4 and 5
2.	Establish service voltage to the photometer.	→ Section 5
3.	Connect photometer to PC.	<p>3.1: On the TurbiGuard, remove cover (arrow) to the Ethernet interface.</p> <div style="border: 1px solid black; padding: 5px; background-color: #f0f0f0;"> <p> Damage to the photometer caused by moisture inside the instrument: The cover to the Ethernet interface may be removed only under dry conditions.</p> </div> <div style="text-align: center;">  </div> <p>3.2: Connect the TurbiGuard via Ethernet to the PC. The PC searches for an IP address for about 1 minute and then reports that a LAN connection with limited connectivity is present. If the connection cannot be established within this time, the IP address of the PC must be adjusted (→ Reference Manual).</p>

	WORK STEP	PROCEDURE
4.	Establish communication between PC and TurbiGuard.	<p>4.1: Launch your web browser and enter this address line: <a href="http://169.254.1.1">http://169.254.1.1</a></p> <p>An Internet page for registering the photometer appears.</p> <p>4.2: In the <b>Code</b> entry field, enter the number <b>0</b> and press <b>Register</b>.</p> <p> Default code is <b>0</b>.</p> <p>The TurbiGuard communication software opens.</p>
5.	<p>Select language.</p> <p> Below the menu tree is a pull-down menu for language selection.</p>	<p>Select the desired language from the pull-down menu.</p> <p> The languages are continually expanded.</p>
6.	<p>Configure.</p> <p> For the first commissioning, at least the current outputs and the limits have to be defined. All other parameters are described in the Reference Manual.</p>	<p>6.1: Set current outputs → Section 6.3</p> <p>6.2: Set limits → Section 6.4.</p>
7.	Perform zero calibration.	→ Section 6.2
8.	<p>Enter individual access code.</p> <p>If no access code is required, skip this step.</p> <p> A forgotten access code can be cleared only by a SI-GRIST service engineer.</p>	<p>8.1: Select <b>Configuration</b> menu.</p> <p>8.2: Enter your individual code in the <b>Access code</b> entry field.</p> <p>8.3: Click the <b>Save</b> button to activate the new code.</p>
9.	Complete procedure.	<p>Click the <b>logout</b> button.</p> <p>You can now remove the Ethernet cable from the photometer and screw on the cover again.</p>

## 6.2. Perform zero calibration

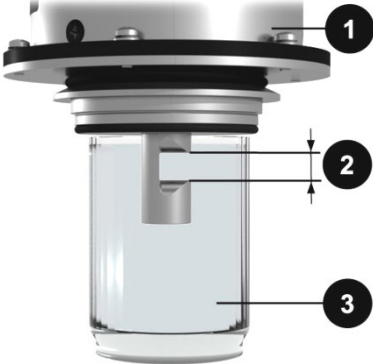

	WORK STEP	PROCEDURE
1.	<p>Prepare system for zero calibration and establish connection to TurbiGuard.</p> <div style="border: 1px solid black; padding: 2px; width: fit-content; margin: 10px auto;"> <p><b>i</b></p> </div>	<p>1.1: Prepare photometer as specified in Section 6.1.</p> <hr/> <p><b>1.2a:</b> Zero calibration in the sample line: If clean, bubble-free water is in the line (e.g. after CIP cleaning), a zero calibration can be performed without disassembling the photometer. If this is not possible, proceed according to step 1.2b.</p> <p><b>1.2b:</b> Zero calibration outside the sample line:</p> <div style="background-color: #f0f0f0; padding: 5px; border: 1px solid black; margin: 5px 0;"> <p> Danger when removing the photometer if the sample line has not been previously emptied: The photometer must not be removed from a line that has not been emptied or only partially emptied; doing so may lead to flooding and thereby to instrument damage or bodily injury.</p> </div> <p>1. Ensure that the sample line is empty.</p> <p>2. Remove the photometer (1) from the sample line and submerge the measurement opening (2) in clean, bubble-free water.</p> <p>The measurement opening (2) must be completely submerged in the water and no external light is allowed to penetrate (if necessary, cover with a black cloth or use a <b>non-transparent</b> container (3). A transparent container is used here only for illustrative reasons.</p> <div style="text-align: center; margin: 10px 0;">  </div> <p> <b>1</b> Photometer  <b>2</b> Measurement opening (completely in the water)  <b>3</b> Container with clean water                 </p>

	WORK STEP	PROCEDURE
2.	Select <b>Recalibration</b> menu.	Select <b>C1 Turb</b> channel.
3.	Perform zero calibration.	<p>Click the <b>initiate...</b> button. The zero calibration is now performed.</p> <p>If the adjustment was successful, <b>Adjustment OK</b> appears.</p> <p>If the calibration check was <b>not</b> successful, <b>Adjust. fault</b> appears. In this case, repeat adjustment and check the points in the following list one after the other:</p> <ul style="list-style-type: none"> <li>■ Soiled window on the sensor head. → Reference Manual</li> <li>■ Air bubbles in the water.</li> <li>■ Soiled optics in the instrument. → Reference Manual</li> </ul> <p> If the check was not successfully completed, contact your country representative. → Section 10</p>
4.	Complete procedure.	<p>Click the <b>logout</b> button.</p> <p>Put the instrument in its initial state.</p>



### 6.3. Setting the current output



	WORK STEP	PROCEDURE
1.	Establish connection to the TurbiGuard.	Prepare photometer as specified in Section 6.1.
3.	Select <b>Curr. outputs</b> menu.	
4.	Select <b>Current 1</b> .	
5.	Select <b>Source</b> .	<ul style="list-style-type: none"> <li>■ <b>Inactive:</b> not active</li> <li>■ <b>C1 Turb:</b> "C1 Turb" channel is active.</li> </ul>
6.	Select range.	MR1 .. MBR (see table below for range definition)
7.	Clicking the <b>Save</b> button activates the changes.	Device in normal operation.

MEASURING RANGE NO.	MEASURING RANGE (DEFAULT)	MEASURING RANGE (CUSTOMER-SPECIFIC)
1 active	0 .. 1000 EBC	
2	0 .. 100 EBC	
3		
4		
5		
6		
7		
8		



If other measuring ranges are needed, you can use this table to re-program.  
 → Reference Manual

## 6.4. Setting the limits

So that the limits are displayed and the outputs are switched, they have to be configured accordingly. → Section 6.3



	WORK STEP	SUPPLEMENTARY INFORMATION
1.	Establish connection to the TurbiGuard.	Prepare photometer as described in steps 5 and 6 Section 6.1.
2.	Select <b>Limits</b> menu.	
3.	“Select <b>Limit 1</b> .”	
4.	Select channel from the <b>Source</b> pull-down menu.	Only <b>C1 Turb</b> is available.
5.	Select channel from the <b>Mode</b> pull-down menu.	<ul style="list-style-type: none"> <li>■ <b>Off</b> (limit monitoring of this channel is deactivated)</li> <li>■ <b>Exceeded</b> (limit active when set threshold value exceeded)</li> <li>■ <b>Undershot</b> (limit active when set threshold value is undershot)</li> </ul>
6.	Enter the desired values in the entry fields <b>Upper limit</b> , <b>Lower limit</b> , <b>“Cut in delay”</b> and <b>Cut out delay</b> .  Click an entry field to change the value.	<ul style="list-style-type: none"> <li>■ <b>Upper limit</b></li> <li>■ <b>Lower limit</b></li> <li>■ <b>Cut in delay</b></li> <li>■ <b>Cut out delay</b></li> </ul>
7.	Click the <b>Save</b> button to activate the changes.	

## 7. Operation

The TurbiGuard can be operated via a SICON (M) or using the web user interface. Their handling and the parameterization of the menu functions are described in detail in the Reference Handbook.

## 8. Servicing



**It is absolutely necessary to observe safety information when performing servicing duties:**

- The instrument must never be operated when the housing is removed.
- The instrument may be opened only by trained personnel.
- The instrument may be opened only in dry conditions.



Servicing schedule

The servicing duties are described in detail in the → Reference Manual.

WHEN	WHO	WHAT	PURPOSE
Annually or if "Humidity" warning appears	Operator	Change desiccant → Reference Manual	Obligatory measure for maintaining the measuring accuracy and for protecting the electronics. Interval depends on operating and ambient conditions.
Annually or as needed	Operator	Check the sensor window for soiling → Reference Manual	Obligatory measure for maintaining measuring precision. Interval depends on the sample.
Annually or as needed	Operator	Clean the sensor head → Reference Manual	Obligatory measure for maintaining measuring precision. The interval depends on sample.
Annually or as needed	Operator	Zero calibration of the photometer → Section 6.2	Maintain measuring accuracy.
As needed	Operator	Replace gaskets on Varivent® housing → Reference Manual	Maintain sealing of the process line.

Table 1: Servicing schedule

## 9. Troubleshooting



The following measures can be used for troubleshooting. A SICON control unit or web browser is required for analyses of warning and error messages; this is described in detail in the → Reference Manual.

DETECTABLE MALFUNCTION	MEASURES
Occurrence of a warning or error message	Analyze this message as described in the Reference Manual or take the following steps.
The measuring value is wrong	<ul style="list-style-type: none"> <li>■ Make sure that the sample in the product line is in accordance with the operating conditions. → Section 2.2</li> <li>■ Check whether the photometer is correctly mounted. → Section 4</li> <li>■ Ensure that the servicing duties have been performed according to the servicing schedule. → Section 8</li> <li>■ Perform a zero calibration of the photometer. → Section 6.2</li> <li>■ Check the dry chamber in the housing. → Reference Manual</li> <li>■ Clean the sensor head. → Reference Manual</li> </ul>
No display or indication <b>(only with SICON)</b>	<ul style="list-style-type: none"> <li>■ Check whether the service voltage is correctly connected to the SICON. → Reference Manual</li> </ul>

If the listed measures do not result in the desired results, please consult with customer service. → Section 10

## 10. Customer service information

Should you have any questions, please contact the responsible service center in your country or region. If this is not known, SIGRIST-PHOTOMETER AG customer service in Switzerland would be glad to provide you with a contact address.

A current list of all SIGRIST country representatives is available on the Internet at: [www.photometer.com](http://www.photometer.com).

Please have the following information ready when you contact a SIGRIST service center or customer service:

- The serial number of the TurbiGuard. → Section 2.1.7
- A description of instrument behavior and the work steps when the problem occurred.
- A description of what you did when trying to solve the problem yourself.
- The documentation of the third-party products you use in conjunction with the photometer or peripheral devices.

## 11. Decommissioning & storage



**DANGER!**

### Life-threatening voltage inside the instrument:

Connecting the electrical lines is extremely dangerous. Parts of the system can also be damaged. Local regulations for electrical installations must be observed at all times.





**WARNING!**

### Warning! Removal of photometer without first emptying the sample line.

The photometer must not be removed from a line that has not been emptied or only partially emptied; doing so may lead to flooding and thereby to instrument damage or bodily injury.

The aim of decommissioning is to prepare the photometer properly for storage and to conserve it during storage.



	WORK STEP	REMARKS
1.	 <b>Life-threatening voltage inside the instrument:</b> Connecting the electrical lines is extremely dangerous. Parts of the system can also be damaged. Local regulations for electrical installations must be observed at all times. <hr/> Interrupt the power supply to the control unit or control system and remove electrical connections.	
2.	 <b>Removal of the photometer from unemptied or partially emptied line:</b> The photometer must not be removed from a line that has not been emptied or only partially emptied; doing so may lead to flooding and thereby to instrument damage or bodily injury. <hr/> Interrupt the flow rate through the sample line and then empty. Remove the photometer from the sample line and clean the sensor head.	→ Section 6
3.	Check the dry chamber of the instrument. Replace desiccant if necessary.	→ Reference Manual
4.	Disassemble control unit.	→ Reference Manual
5.	Make sure that all covers are closed and all locks on the instrument and control unit are locked.	

**Storage**

There are no special requirements for storing the instruments. However, please note the following information:

- The photometer and control unit contain electronic components. Storage for such components must fulfill the usual conditions. It is important to note that the storage temperature must be between -20 and +50°C.
- All components that come into contact with the sample during operation have to be dry and clean for a longer period of time before being put into storage.
- The photometer, control unit and accessories must be protected from weather factors, condensing humidity, and aggressive gases.

## 12. Packaging & transport

The original packaging materials of the photometer should be used for packaging the photometer and its peripheral components if possible. If the original packaging is no longer available, note the following information:

- Before packaging, close the openings of the SICON with adhesive tape or plugs so that no packaging materials can penetrate inside.
- The photometer contains optical and electronic components. Make sure that the packaging protects the instrument from damaging impact during transport.
- Package all peripheral devices and accessory parts separately and label each part with the serial number (→ Section 2.1.7). This prevents confusion and mix-ups later while also making it easier to identify parts.

When packaged in the way described above, the photometer and control unit can be transported by the usual shipping methods and in all positions.

## 13. Disposal



Disposal of the photometer and its peripheral devices is to be carried out in compliance with regional legal regulations.

The photometer and control unit have no environmentally damaging sources of radiation. The materials listed below should be disposed of or recycled as described in the following table:

CATEGORY	MATERIALS	DISPOSAL POSSIBILITIES
Packaging	Cardboard, paper	Reuse as packaging material, local disposal points, incineration plants
	Protective foils, Styrofoam	Reuse as packaging material, recycling
Electronics	Print boards, electro-mechanical components	To be disposed of as electronic waste
Desiccant	Rubingel	Residual waste (chemically harmless)
Optics	Glass, sapphire	Recycling via centers for recycling glass and waste metal
Housing	Stainless steel	Waste metal disposal centers
	ABS	Incineration plants, waste disposal sites

Table 2: Materials and their disposal

## 14. Spare parts

The parts mentioned in this documentation and their article numbers are listed in the table below:

ART. NO.	ARTICLE NAME	REMARKS
108247	O-ring EPDM 60 x 3, 75 shore A	Material EPDM, 60 x 3 mm
111391	Desiccant bag, 30g	Sealed packaging, unlimited shelf life
112379	O-Ring Nitril 60x3 70 shore A	Material Nitril/NBR, 60 x 3mm
112698	O-Ring Viton 60x3 75 shore A	Material Viton/FPM, 60 x 3mm
114446	O-ring FFPM 60 x 3, 80 shore A	Material FFPM, 60 x 3 mm
120444	Instrument cable 8-pole with plug	Length 10 m

Table 3: Spare parts and article numbers

# 15. Appendix

## 15.1. Mounting dimensional drawing TURBIGUARD-MB

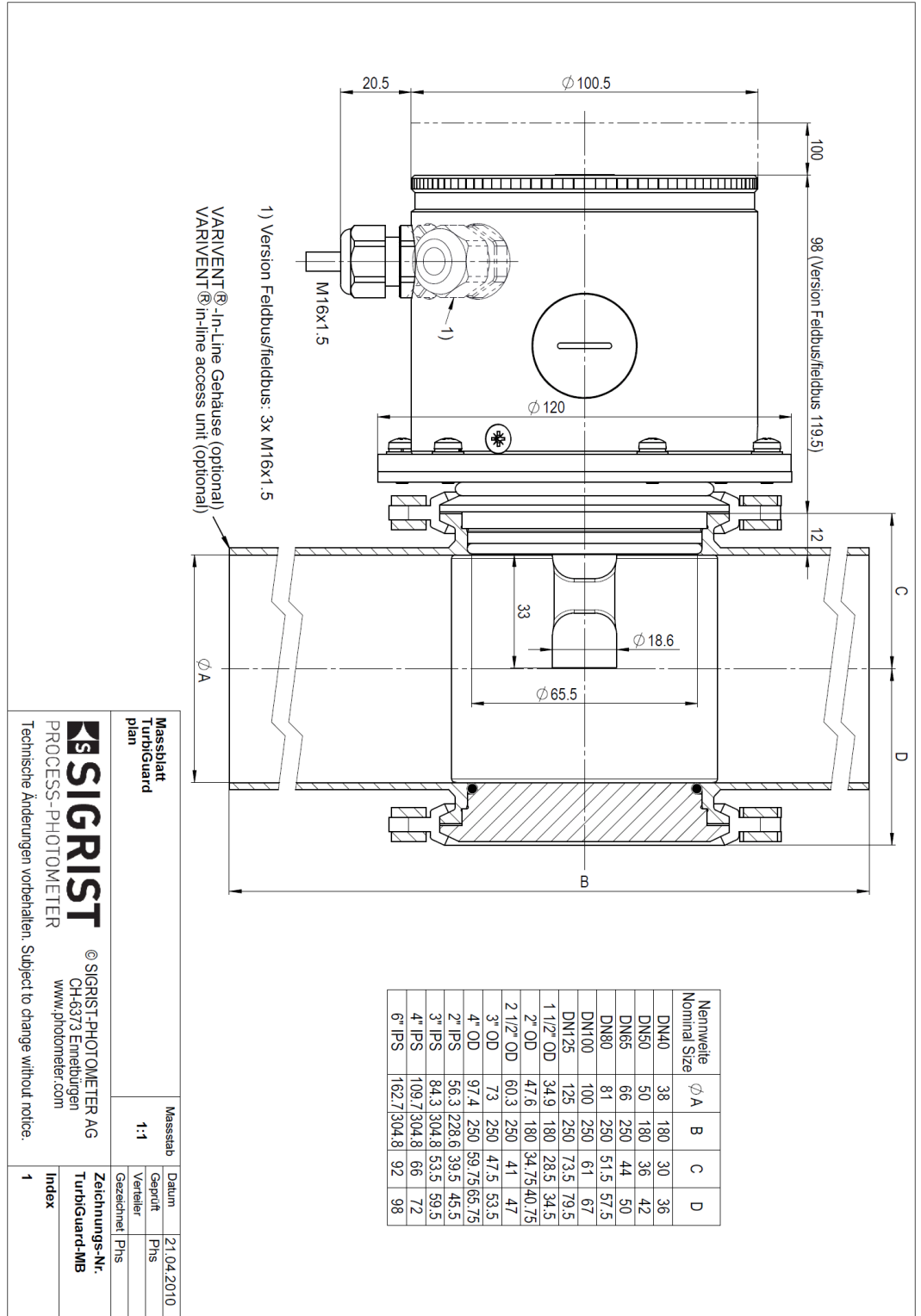



## 15.2. Overview of TurbiGuard gaskets

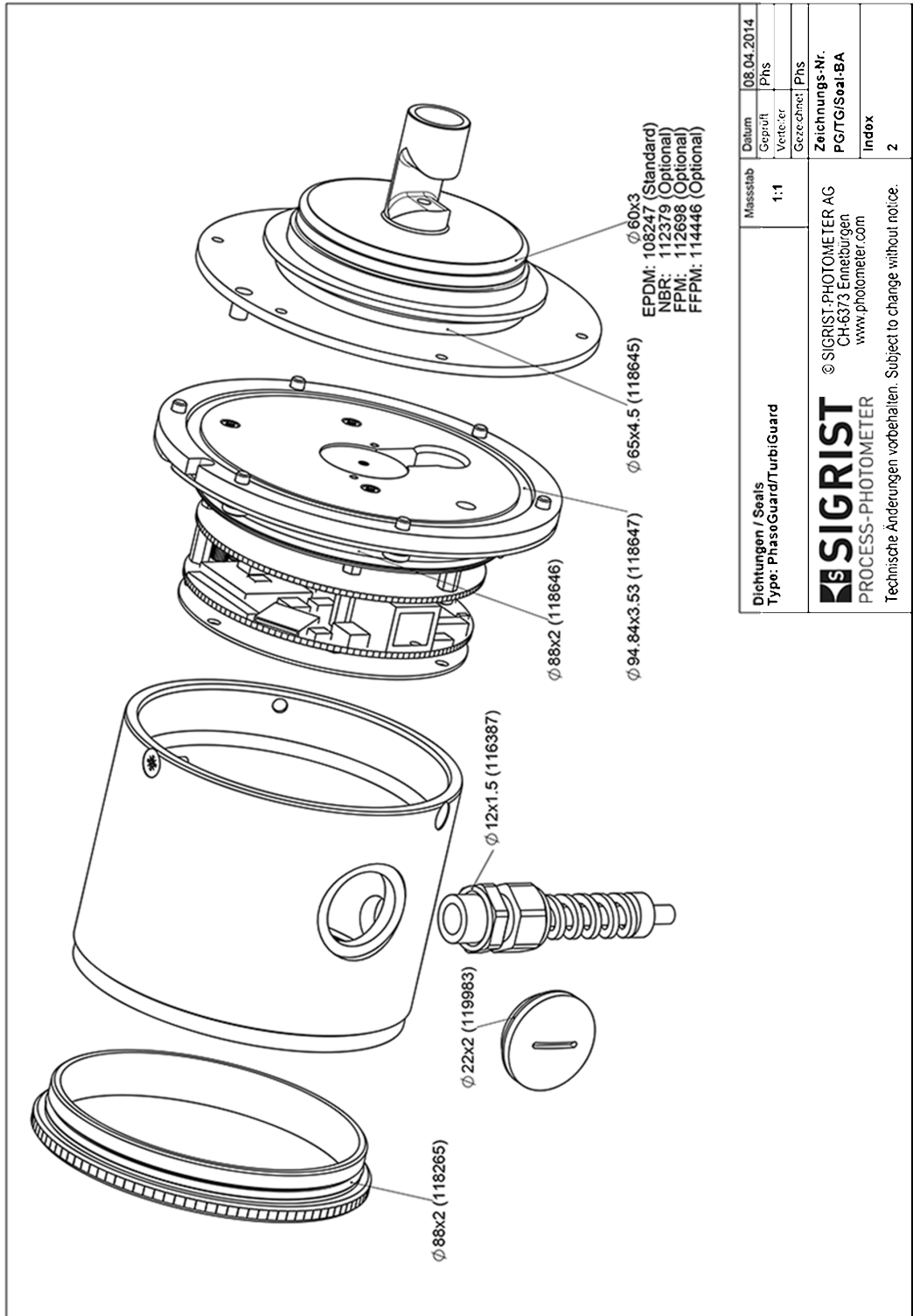

### 15.3. Connection diagram

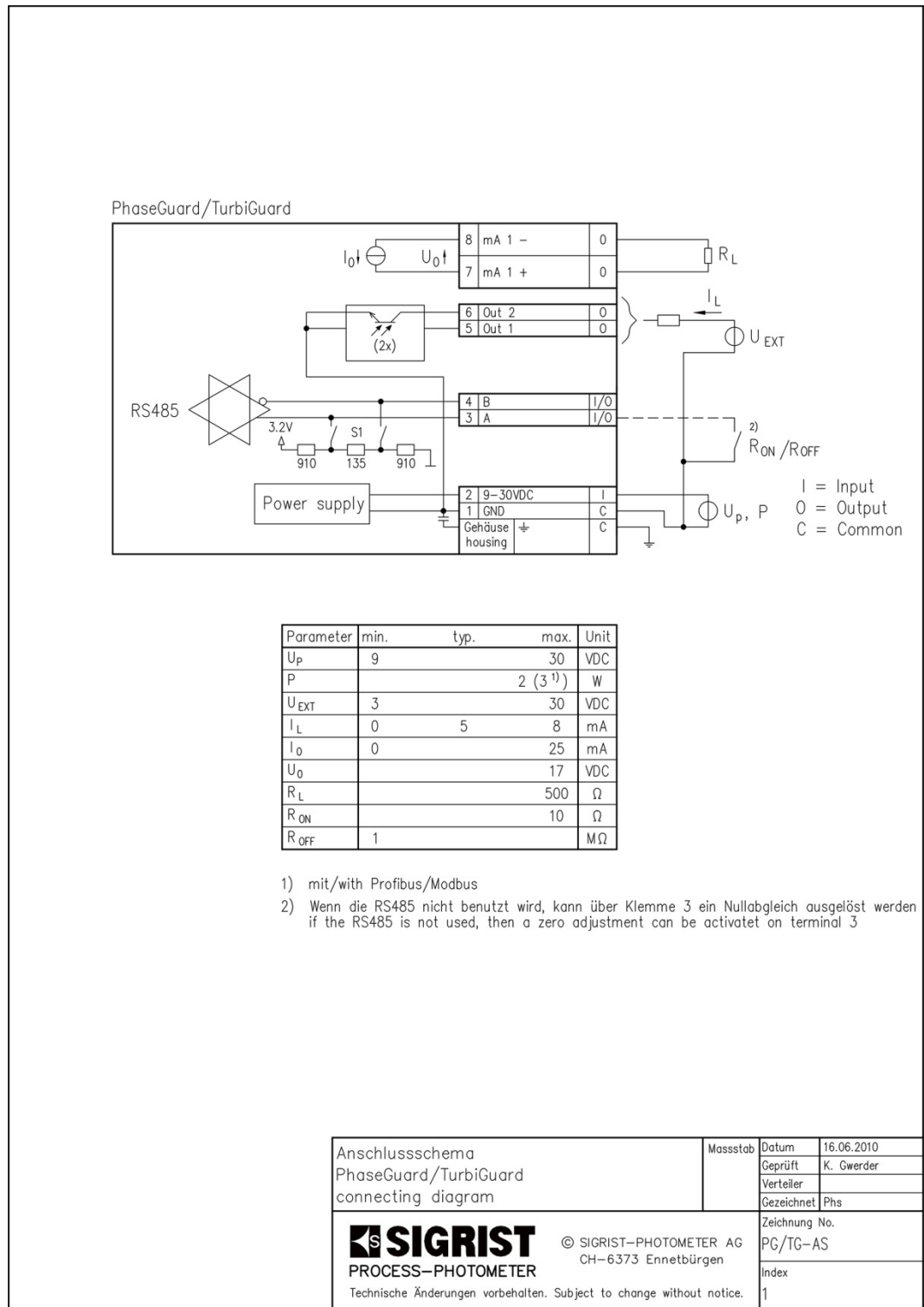

# 1. Index

<b>A</b>		<b>M</b>	
Article numbers.....	27	Mounting .....	13
<b>B</b>		Mounting position .....	13
Behavior in emergency .....	9	<b>P</b>	
<b>C</b>		Packaging .....	26
CE mark .....	4	Pictograms.....	2
Commissioning .....	17	Proper use .....	4
Configure current outputs.....	21	<b>R</b>	
Configure limits.....	22	Rating plate .....	6
Conformity of the product .....	4	Residual risk.....	11
Connections, length .....	16	<b>S</b>	
Cross section .....	16	Scope of delivery.....	7
Customer service.....	24	Service center .....	24
<b>D</b>		Servicing duties.....	23
Dangers .....	5	Servicing schedule.....	23
Decommissioning .....	25	Spare parts .....	27
Disposal .....	27	Storage.....	26
<b>E</b>		<b>T</b>	
EMC.....	4	Technical data.....	8
Environmental damage.....	27	Terminal connection box.....	16
European Union, EU.....	4	Terms, glossary .....	ii
Explanation of symbols.....	2	Transport .....	26
<b>G</b>		<b>U</b>	
Guidelines .....	4	Use restrictions .....	4
<b>H</b>		<b>V</b>	
Horizontal .....	12	Vertical .....	12
<b>I</b>		View of a measuring station .....	3
In-line housing .....	12	<b>W</b>	
Installation, electrical .....	15	Warning symbols on the instrument	11
Internet .....	24	<b>Z</b>	
		Zero calibration .....	19

SIGRIST-PHOTOMETER AG  
Hofurlistrasse 1  
CH-6373 Ennetbürgen  
Switzerland

Tel.+41 41 624 54 54  
Fax+41 41 624 54 55  
info@photometer.com  
www.photometer.com